



WELLSPRING 100



User Manual

TABLE OF CONTENTS

PRODUCT INFORMATION

Features.....	5
Parts.....	6
Dimensions.....	7

PRODUCT INSTALLATION

Pre-Installation.....	8
Installation.....	9

PRODUCT OPERATION

How To Use.....	13
-----------------	----

MAINTENANCE

Cleaning.....	14
Short Term Non-Use.....	14
Warranty.....	15

FEATURES

- High-quality ABS material
- Premium quality metal inlet and installation parts
- Dual nozzle
- Ambient temperature bidet wash
- Adjustable water pressure
- Unified internal brass valve
- Durable braided metal cold water hose
- No electricity or batteries required
- Adjustable toilet fit
- One-year warranty

PARTS

Bidet attachment

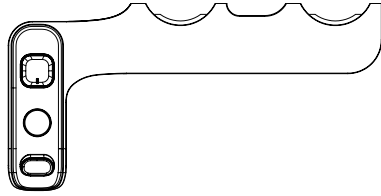

2 Adjustable mounting brackets

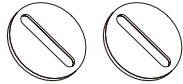

2 Adjustable Splice mounting bracket tray

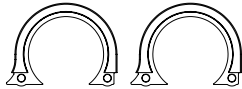

*T-Valve connector with rubber cone washer (7/8" x 7/8" x 3/8")

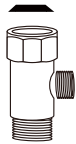

27.5" Braided metal hose



2 Non-slip mats



Teflon tape



3 Toilet bumpers



DIMENSIONS

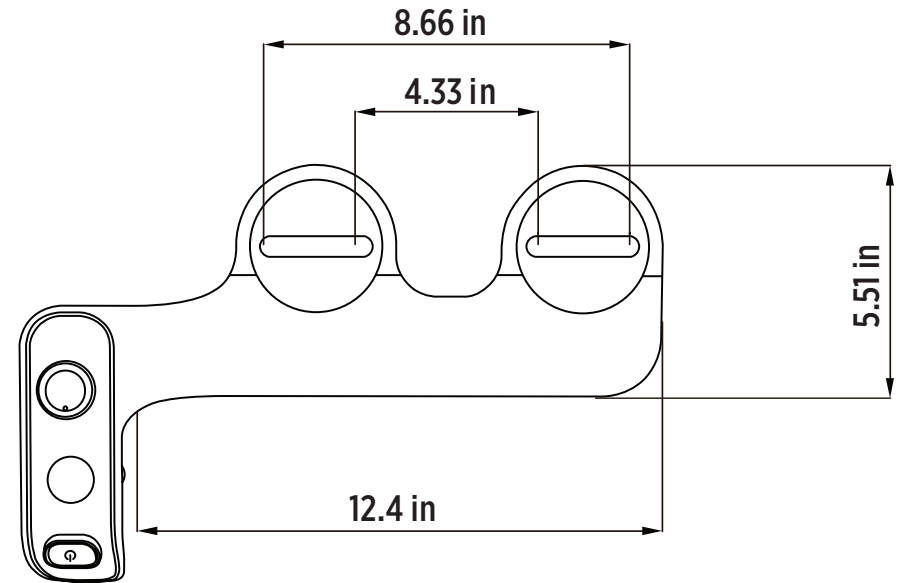

*Alternate fittings available, contact bidets@bemismfg.com

PRE-INSTALLATION

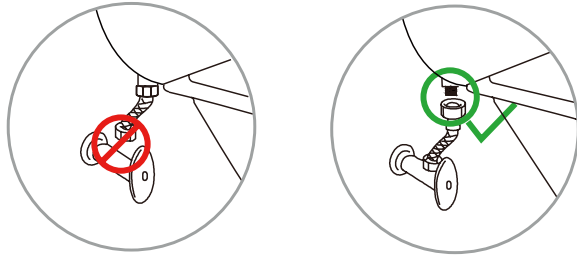

Please be advised that the provided T-Valve should be installed at the fill valve under the toilet tank, NOT down at the water supply coming from the wall.

Inspect your current water supply line that connects to the toilet tank fill valve to ensure it is a flexible water supply hose before installing the Wellspring 100. The hose needs to be 7/8" (to connect to the T-Valve we provided) on one end and either 3/8" or 1/2", depending on your wall valve, on the other end.

If you do not have access to the fill valve under the toilet tank, contact Bemis Customer Service at 920.467.4621 and we may be able to provide alternative fittings.

INSTALLATION



1. Remove the existing toilet seat by locating the bolts and nuts, typically under a plastic cover, and removing them first.

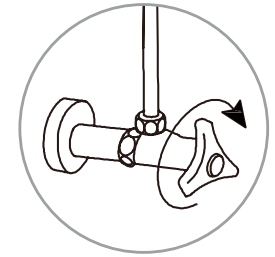

2. Close the water supply valve and flush the toilet completely so that there is little to no water left in the toilet tank.

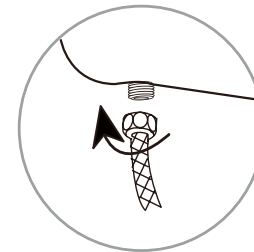

3. Disconnect the water hose from underneath the toilet tank.

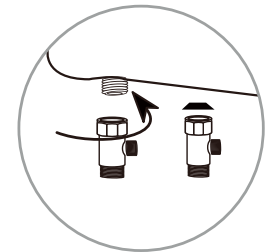

4. Connect the 7/8" T-Valve to the toilet fill valve where you just removed the water hose from.

Make sure the rubber washer is properly seated with the narrow side up.

INSTALLATION (CONT.)

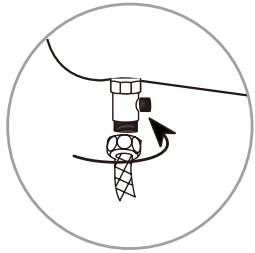

5. Attach the water supply hose that comes from the water shut off to the bottom of the T-Valve.

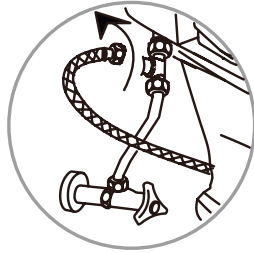

6. Connect the metal hose we supplied to the open side of the T-Valve.



9. Place the circular mounting brackets into the bidet attachment.

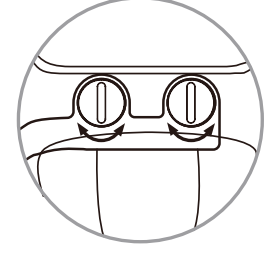

10. Place the bidet on the toilet with the mounting brackets over the bolt holes and make any needed adjustments to make sure the bidet is centered on the toilet.

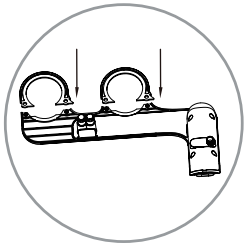

7. Install the splice mounting brackets tray on the bidet body.

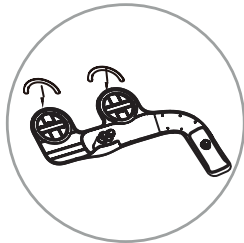

8. Insert the rubber non-slip mats to the bottom of the bidet.



11. Place the toilet seat back on the toilet over the bidet and secure the bolts down so that the seat and bidet attachment are stable.



12. Connect the hose from step 6 to the bidet water connection underneath the handle of the Wellspring 100.

INSTALLATION (CONT.)

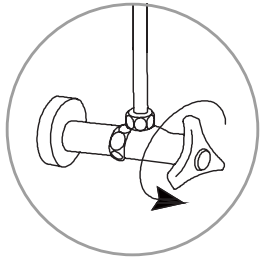

13. Slowly turn the water supply valve back on, check for leaks, and test the unit for functionality.



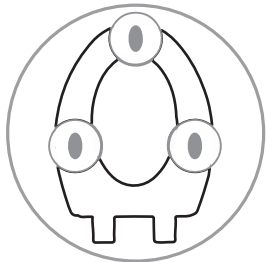

14. After installing your bidet attachment, check to see if there is a gap between the toilet base and toilet seat.



15. If necessary, place the bumpers on the underside of your toilet seat as indicated above.

HOW TO USE

For back wash, turn the control knob to the left towards the “” position.

For front/feminine, turn the control knob to the right towards the “” position.

For the self cleaning function, turn the control knob to the middle towards the “” position.

The further the knob is turned, the higher the water pressure will be. Press the button to activate the flow of water.

If there are no immediate leaks, check again in about 5-10 minutes and your Wellspring 100 is ready for use!

If any leaks occur, check all rubber washers and make sure all connections are tight and secure.

CLEANING

Your Wellspring 100 is made with a high grade fire-retardant ABS resin. Using hard cleaning chemicals can weaken the material, causing it to damage and develop cracks.

1. Clean the Wellspring 100 by wiping the surface area with a damp cloth regularly.
2. Do not use harsh detergents or any cleaning tools with bristles on your bidet.

Steam cleaning is the preferred cleaning method for your bidet. For a deep, chemical free clean, consider the BioMist Bidet Cleaner.

SHORT TERM NON-USE

If the product will not be used for more than a few days, it is highly recommended that the water supply valve is turned off.

WARRANTY

Your product is warranted against defects in materials or workmanship for (1) year from the date of original purchase. Defective parts or a defective products returned to Bio Bidet Innovation LLC will be repaired with new or comparable rebuilt parts or exchanged for a refurbished product as determined by Bio Bidet Innovation LLC in their sole discretion.

This limited warranty given by Bio Bidet Innovation LLC covers all defects encountered in normal product use, and do not apply in the following cases:

1. Loss of or damage to product due to abuse, misuse, tampering, Mishandling, improper packaging by you, alteration or fail to follow operating instructions.
2. Use of parts or supplies (other than those by Bio Bidet Innovation LLC dealers that cause damage to product.
3. Replacement of discolored or stained parts caused by chlorine, bleach, ammonia and other chemicals, cleaning supplies, oxidation, normal wear and tear.
4. Damage to or malfunction of the unit as a result of improper and negligent installation.
5. Any and all damages to plumbing, walls, floors, ceiling and personal properties resulting from water leaks or breakage. The product must be used at the user's own risk. Therefore, the owner hereby releases the manufacturer and distributor from any and all claims for damages where the above condition exists.

No implied warranty, including any implied warranty of merchantability or fitness or a particular purpose, applies to Bio Bidet Innovation LLC bidet after the applicable period of the express limited warranty stated above, and no other express warranty or guarantee, except as mentioned above, given by any person or entity with respect to Bio Bidet Innovation LLC shall bind Bio Bidet Innovation LLC. (Some States and provinces do not allow limitations on how long an implied warranty, so the above limitation may not apply to you) Bio Bidet Innovation LLC shall not be liable for revenues or profits, inconvenience, expense for substitute equipment or service, or any other special, incidental or consequential damages caused by the use or misuse of, or inability to use product, regardless of the possibility and foresee-ability of such damages. In no event shall recovery of any kind against Bio Bidet Innovation LLC be greater in amount than the purchase price of the product and causing the alleged damage. Without limiting the foregoing, you assume all risk and liability for loss, damage or injury to you and your property and to others and their property arising out of use or misuse of, or inability to use, the product not caused directly by the negligence or Bio Bidet Innovation LLC. This limited warranty shall not extend to anyone other than the original purchaser of the product.

Thank You



300 Mill Street
Sheboygan Falls, WI 53085
T: 920.467.4621

Bidets@Bemismfg.com
ToiletSeats.com